

# LOUVRE VENTS & AIR DUCT/DEFROSTER HOSE

## Round Style With Non Regulated Swivel Center

Black plastic. OD 3.95" x RO 3".

**Product # V82PD200BK** 2" Hose

**Product # V82PD250BK** 2.5" Hose



## Round Style With Regulated Swivel Center Damper

Black plastic. OD 5.5" x RO 4".

**Product # V823840RBK** 4" I.D. Defroster Hose



## Round Multi-Directional Non Regulated Swivel Center

Black plastic. OD 4.25" x RO 3.38". Snap into 3.38" diameter panel cutout on plenum.

**Product # V82PD338BK**



## Rectangular Air Diffuser Vent

Automotive style black plastic vent with moveable louvres can be mounted horizontal or verticle. Accepts 2.5" I.D. flexible defroster hose . OD 2.2" x 5.4" x 2.31".

**Product # V8214560600A**



**\*\* Other Profiles Are Available. Please Contact Our Sales Department With Your Requirements. \*\***

## Black Wire Reinforced Air Duct / Defroster Hose

Spiral wire reinforced vinyl hose is crush resistant and easily conforms to almost any configuration. Sold in 6 foot minimum cut lengths or bulk rolls of 50 feet.

**Product # V82DH610BK** 2" I.D. x 50 FT

**Product # V82DH615BK** 2.5" I.D. x 50 FT

**Product # V82DH810BK** 4" I.D. x 50 FT



# VENTILATORS

## Aluminum Hingeless Swing Vent

Dual position vent allows for scooping of air in or drawing of air out. Multiple stop points allow for varying levels of flow. Lid contains a weather seal. Features tube style handle and main frame with integral perforated screen. All aluminum construction. May be roof or side mounted.

Product # V8028570AL

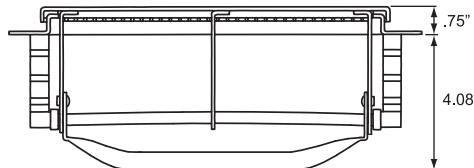

Tube Handle

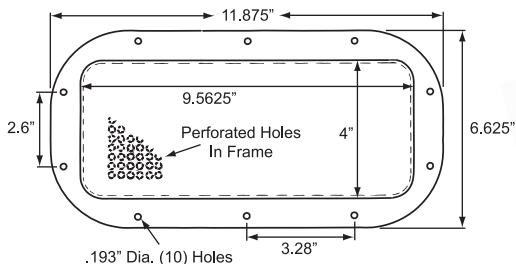

## Aluminum Raised Bucket Hingeless Swing Vent

Dual position vent allows for scooping of air in or drawing of air out. Multiple stop points allow for varying levels of flow. Deep bucket allows for flush interior finish. Lid contains weather seal gasket. Ventilator frame features rod style handle and integral perforated screen. May be roof or side mounted.

Product # V8028626VENTKIT Ventilator, Interior Trim Bezel & Frame Mounting Gasket

Product # V8028626AL Ventilator Only

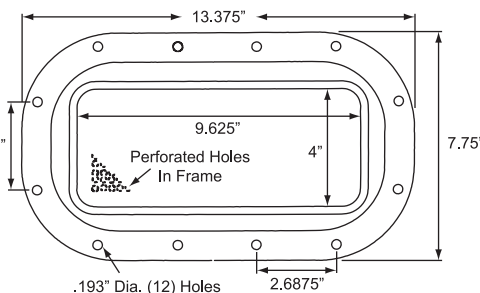
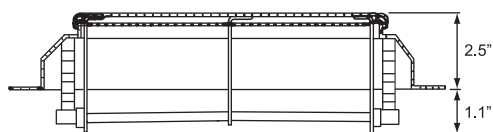

## Black E-Coat Steel With Stainless Lid Hingeless Swing Vent

Dual position vent allows for scooping of air in or drawing of air out. Multiple stop points allow for varying levels of flow. Lid contains a weather seal. Tube style handle and main frame with perforated screen are black e-coated steel. Lid is capped in polished 304 stainless steel. May be roof or side mounted. **\*\* Subject To Prior Sale. Minimum Order Quantity May Apply. \*\***

Product # V8028560SS

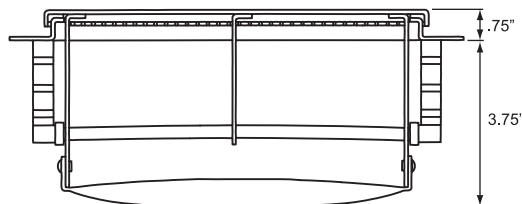

Tube Handle

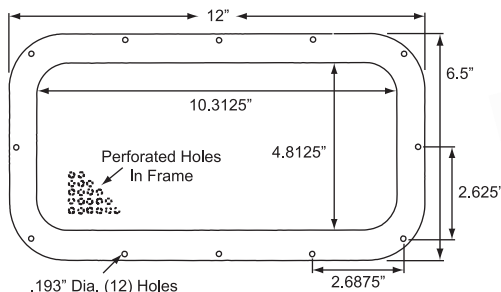

# VENTILATORS

## Parts & Accessories For Hingeless Vents

**Product # V8027560BK** Black Plastic Trim Bezel 2" Deep  
Trim To Desired Depth

**Product # V8027561BK** Black Neoprene Frame Mounting Gasket  
Fits V8028626AL & V8028570AL

**Product # V8028570RR** Replacement Pivot Rod End Roller



## Flat Aluminum Louvre Vent With Shutter Closure

Aluminum front and back plates with integral zinc plated closure.

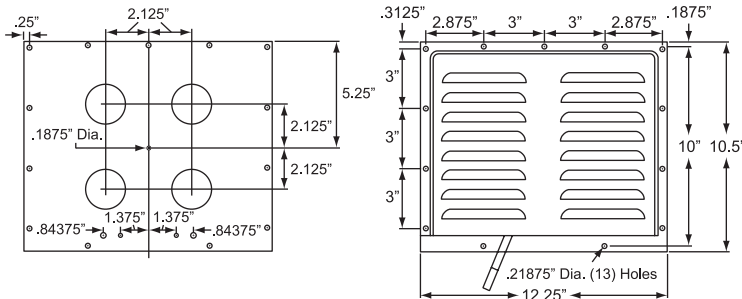

**Product # V80V2000AL**

## Flat Aluminum Louvre Vent Plate - Non Shut-Off

Aluminum plate for surface mounting. No shutter control. Always open.

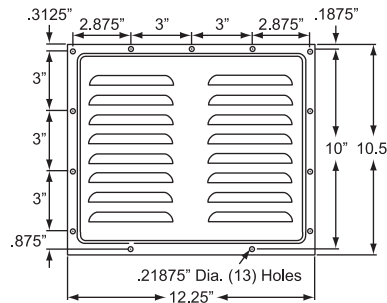

**Product # V80V2200AL**

## Stainless Round Louvre Vent

Type 304 bright finish stainless 5" round flush for surface mounting. Effective venting area 2.02 square inches.

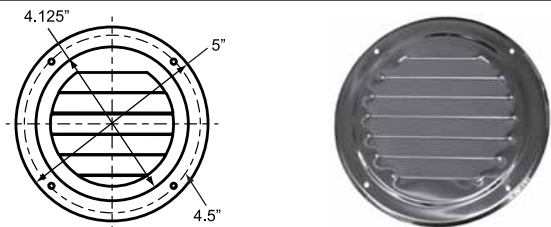

**Product # V80V5000SS**

## Regulative Interior Grille

Rotational shutter plate 7.25" overall diameter allows versatile uses. Available in plated steel or aluminum. Includes closed cell neoprene gasket seal.

**Product # V80G2400AL** Aluminum

**Product # V80G2400ZN** Plated Steel



# VENTILATORS

## Contoured Roof Or Wall Mount Vent

White powder coat finish outside vent housing designed with a water resistant baffle permitting use on roof or wall. Supplied with plated steel regulative grille and gasket.

Product # V80V2400PA

10-32 Threaded Inserts  
On A 6.5" Dia. B.C. (4)

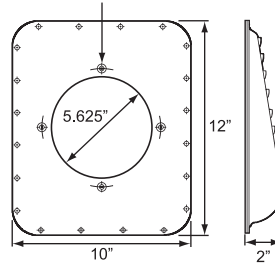

## Contoured Powered 100 CFM Exhaust Vent

Prime finish all steel housing with 12 volt 2.2 amp motor flows 100 CFM static exhaust. Includes interior grille with screen. Vent housing projects 3.6875".

Product # V80V2300PV



## Crank Open Domed Vent

Plastic 14" x 14" translucent dome with aluminum frame, bug screen and 2-1/8" garnish molding. Available with either white or smoke dome. Required opening to place domed vent is 14" x 14".

Product # V801414NWH White Translucent Dome

Product # V801414NSM Smoke Translucent Dome



## Dry Freight And Reefer Vent Door Assemblies

One piece pre-fabricated door assemblies for direct replacement or new construction. Dry freight door sizes either 17" x 7" or 17" x 11.38" in aluminum, white painted or stainless steel. Reefer vent doors are available in door sizes of 14" x 8", 19" x 6" and 19" x 12" in aluminum, white painted or stainless and will accommodate wall thickness of 3". Anti-intrusion screens are available.

**\*\* Please Contact Our Sales Department With Your Requirements For Appropriate Model Selection \*\***



Short Side Opening  
Reefer Vent Doors



Dry Freight Vent Doors



Dry Freight Vent Doors



Long Side Opening Dry  
Freight Vent Doors



Long Side Opening  
Reefer Vent Doors