

HINGES

12" Cast Aluminum Hinge

Features stainless steel pin and zerk grease fitting.

Product # H50120LXAL

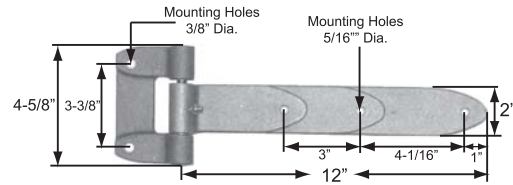

12" Square Corner Hinge

Allows full 270° swing fo door by haning butt mounted to face of body post. Features .500" dia pin and 8 gauge construction.

Product # H504022XZN - Zinc Plated Flush

**** Offset Available with Minimum Order Quantity**

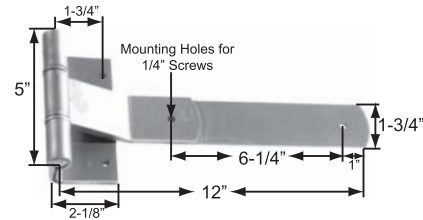

13" Stainless Steel Hinge

Made from Polished 304 Stainless Steel and features nylon bushings and bolt style pin with lock nut design allows full 270° swing and reefer door overseal offset.

Product # H50M414SSR

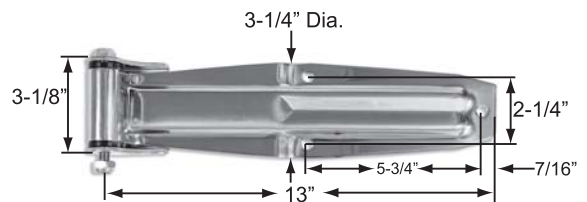

16" Flush - Stamped Strap Hinge

Three Hole Butt

Product # H502016SSP 16" ElectroPolish Stainless

- Steel hinges are 8 gauge material with .500" dia steel pin
- Stainless hinges are 10 gauge material with .500" dia stainless pin

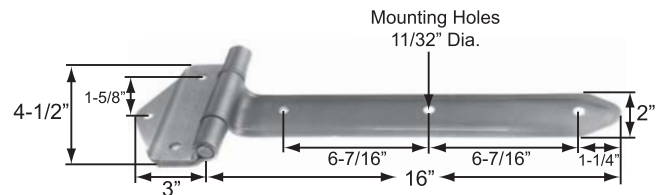

16" Flush Overseal - Stamped Strap Hinge

- Three Hole Butt

Product # H502116XZN 16" Zinc Plated Strap Length

Product # H502116SSP 16" ElectroPolish Stainless

- Steel hinges are 8 gauge material with .500" dia steel pin
- Stainless hinges are 10 gauge material with .500" dia stainless pin

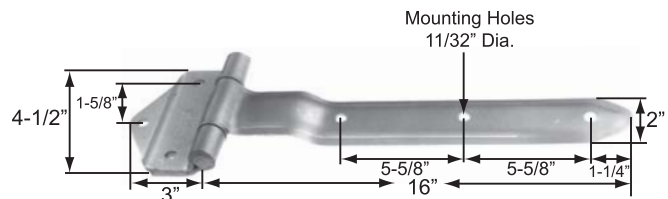

HINGES

16" Flush Reverse Stamped Two Hole Butt Square Corner Hinge

Product # H502216XZN - 16" Zinc Plated Strap Length

- Steel hinges are 8 gauge material with .500" dia steel pin
- Stainless hinges are 10 gauge material with .500" dia stainless pin

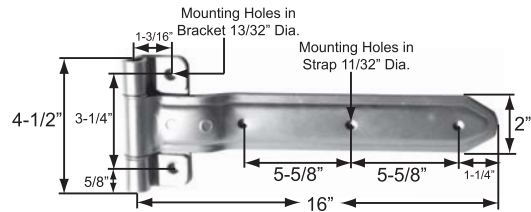

16" Flush Two Hole Stamped Butt Hinge

Product # H502416XZN - 16" Zinc Plated Strap Length

** ElectroPolish Stainless and Powder Coat Finish Available Min. Order Qty's May Apply

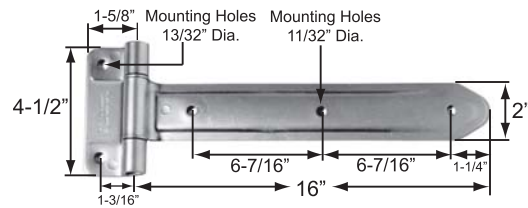

16" Flush Overseal - Stamped Strap Hinge Two Hole Narrow Butt

Product # H502516XZN - 16" Zinc Plated Strap Length

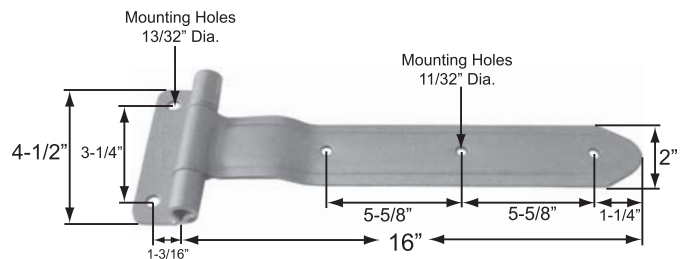

16" Flush Two Hole Stamped Narrow Butt 3400-Series

Economy Hinge - Features single thickness seam welded butt and seam welded leaf

Product # H503416XZN - 16" Zinc Plated Strap Length

** ElectroPolish Stainless Also Available

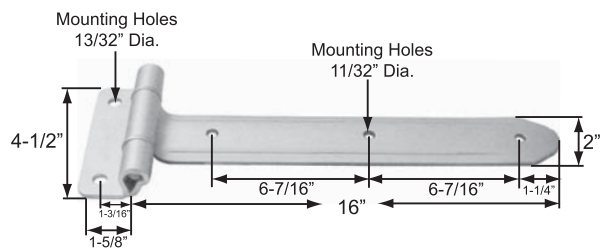

16" Flush Overseal Stamped 3500-Series Narrow Butt

Economy Hinge - Features single thickness seam welded butt and seam welded leaf

Product # H503516XZN - 16" Zinc Plated Strap Length

** ElectroPolish Stainless Also Available

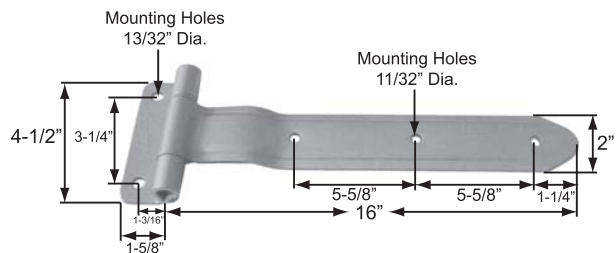

HINGES

16" Laminated Hinge

Heavy duty triple laminated hinge features .5" diameter pin, 8 gauge construction and opens 180°.

Product # H50316XXZN Zinc Plated Steel

Product # H50316XNSS Natural Finish 304 Stainless, 10 Gauge Construction

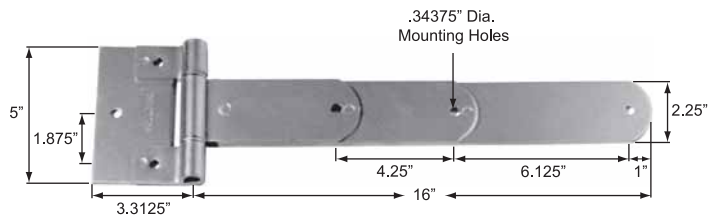

16" Extended Butt Laminated Hinge

Heavy duty triple laminated hinge features .5" diameter pin and 8 gauge construction with 4-15/16" long butt allowing 270° swing when side of post mounted.

Product # H50716XXZN Zinc Plated Steel Flush

Product # H50716XSSP Electropolish 304 Stainless, 10 Gauge Construction

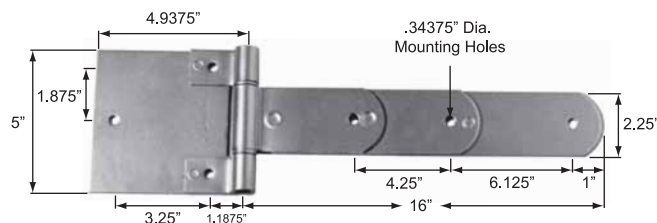

16" Square Corner Hinge

Allows full 270° swing of door by having butt mounted to face of body post. Features .5" diameter pin and 8 gauge construction.

Product # H504026XZN Zinc Plated Steel Flush

Product # H504026SSP Electropolish 302 Stainless, 10 Gauge Construction

Product # H5140164ZN Zinc Plated Steel 7/16" Offset With Countersunk Mounting Holes For 1/4" Flat Head Screws

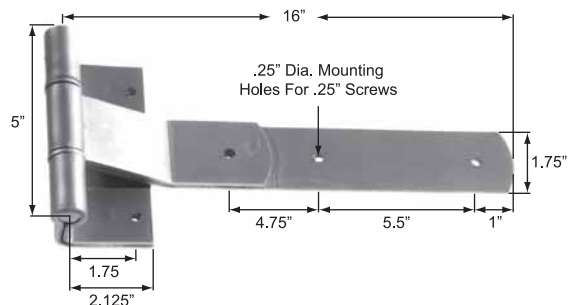

16" Laminated Extra Heavy Duty Hinge

Double laminated hinge produced from .25" steel for severe duty. Features .5" diameter pin, .3281" diameter mounting holes in butt and .2813" diameter mounting holes in strap.

Product # H50926XXPC Grey Powdercoat Over Zinc Plated Finish

