

FLEXIBLE BULBSEAL WEATHERSTRIP

Duplex seals combine dense rubber, wire and sponge rubber in a single profile. Patented wire carrier is contained within the extruded rubber grip section to ensure a weather tight seal on the mounting flange. Sponge rubber bulb effectively seals out water, dirt, air, and noise. Use for sealing of doors, hoods, decklids, tailgates, windows, etc. Standard stock is black.

1301 End Mount Bulbseal

Sold in rolls of 100 FT.

Product # R22X1301BK

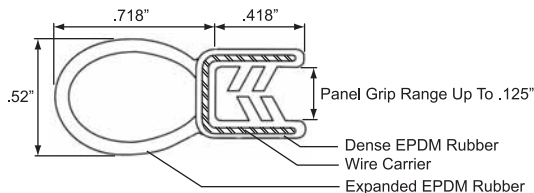

1302 Side Mount Bulbseal

Sold in rolls of 100 FT.

Product # R22X1302BK

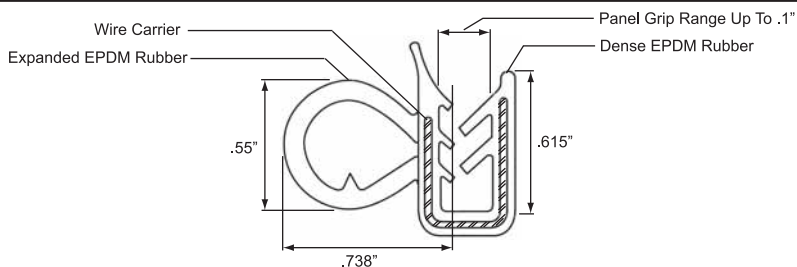

1327 Side Mount Bulbseal

Sold in rolls of 165 FT.

Product # R22X1327BK

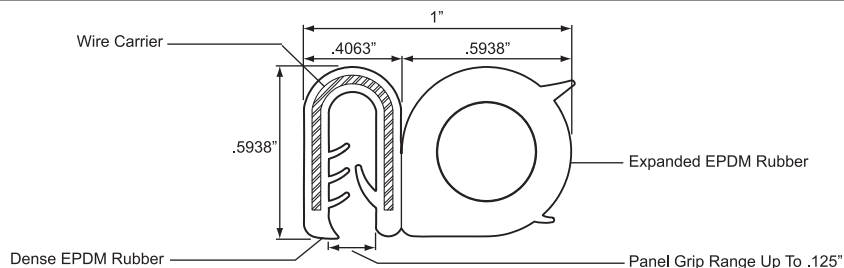

1426 Side Mount Bulbseal

Sold in rolls of 100 FT.

Product # R22X1426BK

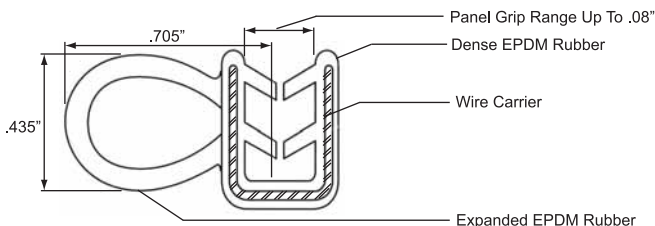

1494 Side Mount Bulbseal

Sold in rolls of 100 FT.

Product # R22X1494BK

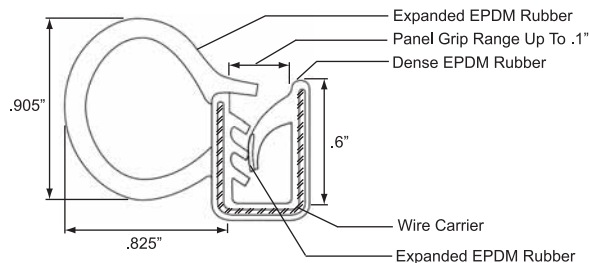

**** Other Bulb Profiles Are Available, Minimum Order Quantities May Apply. Please Contact Your Pomar Sales Representative With Your Requirements. ****

FLEXIBLE BULBSEAL WEATHERSTRIP

1512 Black EPDM Side Mount Bulbseal

Self gripping extruded profile with wire carrier. Fits up to 5/32" thick panel. Sold in rolls of 165 FT.

Product # R22X1512BK

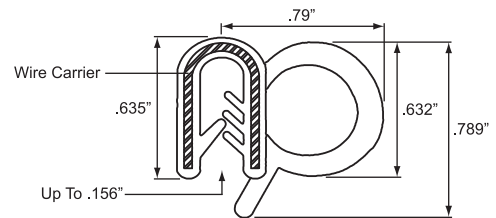

1531 Black EPDM Side Mount Bulbseal

Self gripping extruded profile with wire carrier. Material capacity up to .125" thick. Sold in rolls of 165 FT.

Product # R22X1531BK

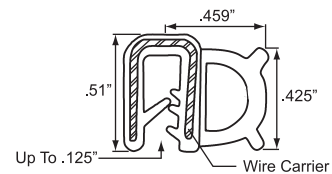

1536 Black EPDM Side Mount Bulbseal

Self gripping extruded profile with wire carrier. Material capacity up to .125" thick. Sold in rolls of 165 FT.

Product # R22X1536BK

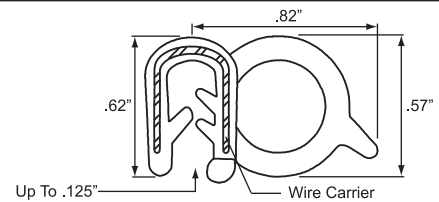

1520 Black EPDM Inline Mini Bulbseal

Self gripping extruded profile with wire carrier. Material capacity up to .0625" thick. Sold in rolls of 165 FT.

Product # R22X1520BK

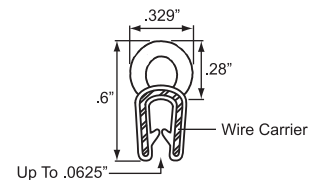

1521 Black EPDM Inline Large Bulbseal

Self gripping extruded profile with wire carrier. Material capacity up to .125" thick. Sold in rolls of 165 FT.

Product # R22X1521BK

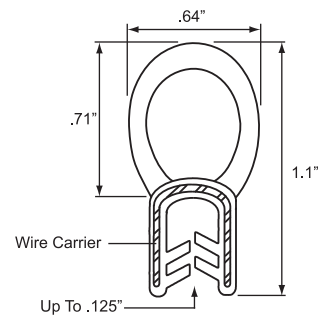

1523 Black EPDM Inline Bulbseal

Self gripping extruded profile with wire carrier. Material capacity up to .125" thick. Sold in rolls of 165 FT.

Product # R22X1523BK

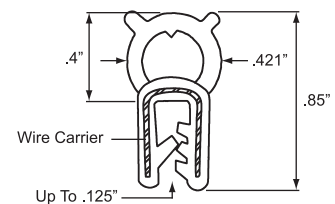

**** Other Bulb Profiles Are Available, Minimum Order Quantities May Apply. Please Contact Your Pomar Sales Representative With Your Requirements. ****

BULBSEAL, EDGETRIM & WINDOW CHANNEL

209-0201 End Mount Black Bulbseal

Sold in rolls of 50 metres.

Product # H412090201BK

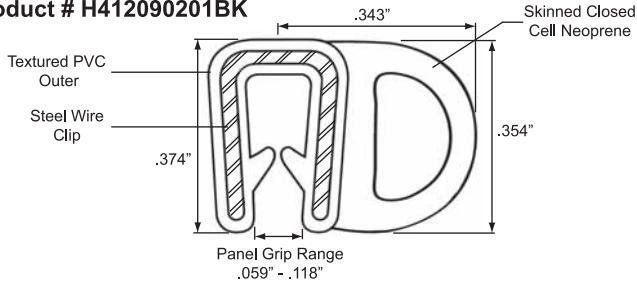

209-0212 Side Mount Black Bulbseal

Sold in rolls of 100 metres.

Product # H412090212BK

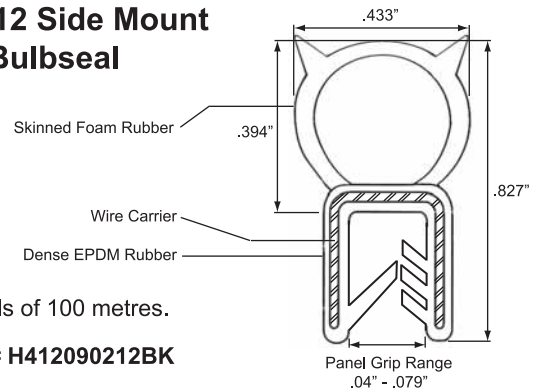

Self Gripping Edge Trim Protectors Feature Extruded Textured Vinyl Exterior With An Integral Flexible Wire Carrier Core For Reinforcement And Flange Mounting

Single Fin Black Edgetrim

Panel grip range .125" - .1875".
Sold in rolls of 100 FT.

Product # R22XX500BK

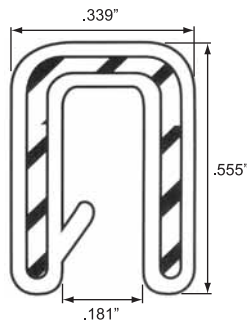

Double Fin Black Edgetrim

Panel grip range .04" - .1".
Sold in rolls of 100 FT.

Product # R22XX510BK

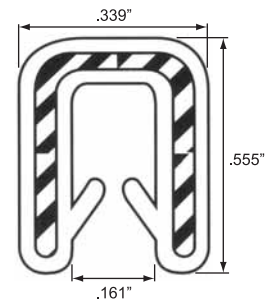

Double Fin Black Edgetrim

Panel grip range .07" - .13".
Sold in rolls of 350 FT.

Product # R22XX610BK

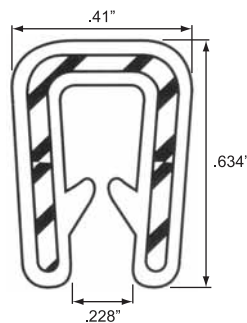

Single Fin Black Edgetrim

Panel grip range .2" - .245".
Sold in rolls of 250 FT.

Product # R22XX710BK

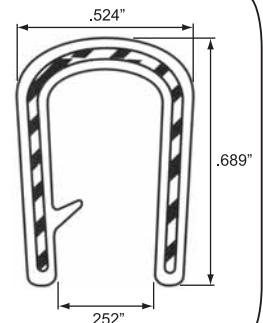

Black Tri-Pile Glass Run Channel

Tri-pile glass run channel offers considerable advantages over rubber extrusions in terms of weight, appearance and near flush setting with only 3 mm of set back. Sold in rolls of 2500 FT.

Product # R22TP09509645

